

Theater de Vest Grote zaal

vloer links

2 Kw★	
61	62
63	64
65	66
67	68
5 Kw★	
69	70

vloer rechts

2 Kw★	
161	162
163	164
165	166
167	168
5 Kw★	
169	170

boven

HB trek 42

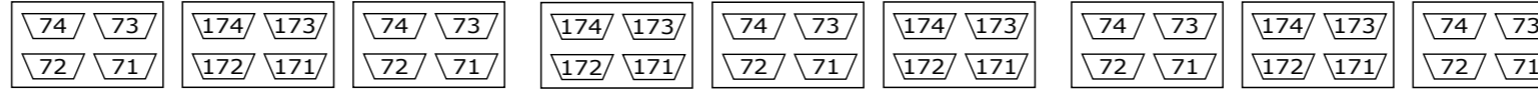

onder

zijbrug links

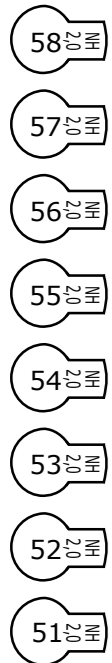

zijbrug rechts

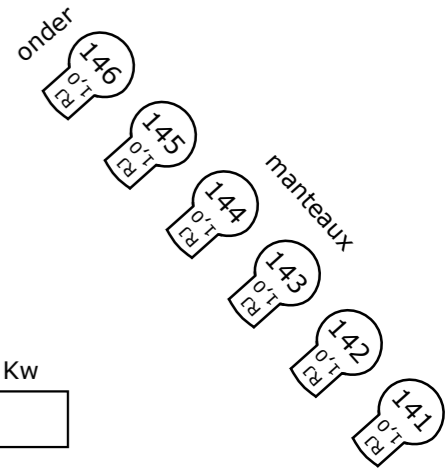
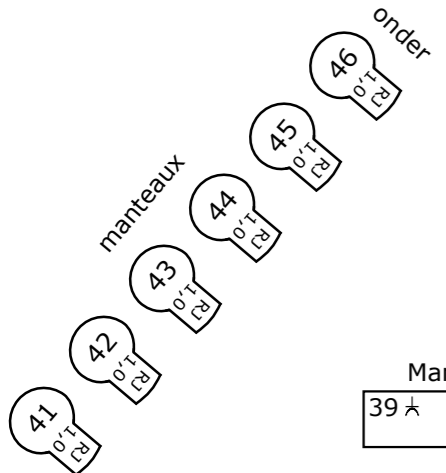
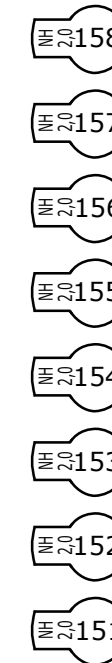

omloop 2 Kw		
97★		
96★		
95★		

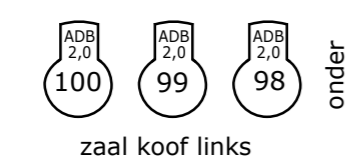

Wand en Vloerstrip leds RGBW
 (R) W.181 + V.185 = ch.147
 (G) W.182 + V.186 = ch.148
 (B) W.183 + V.187 = ch.149
 (W) W.184 = ch.150

Tredeverlichting 188
 (tijdens in en uit -loop: 7 - 12 %)

Zaallicht
 Preset zaal 48@full
 Downlights 50@full,
 Kleurtemp 49 (@0=warm, @FF=Wit)

 Downlights (moodspots)
 80, 82, 84, 86 amber (FF)
 81, 83, 85, 87 kleurtemp. (min. 35%)
 (i.v.m. veiligheid)

NH - 1 Kw 13°- 36°
 RJ - 1 Kw 28°- 54°
 NH - 2 Kw 13°- 36°
 ADB - 2 Kw 15°- 40°

Sel. PC 1,2 Kw
 4,5°- 62°
 ADB C201 2 Kw
 5°-65°

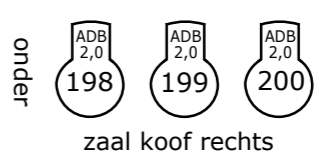

omloop 2 Kw		
197★		
196★		
195★		

omloop 2 Kw	
94★	
93★	



omloop 2 Kw	
91★	
92★	

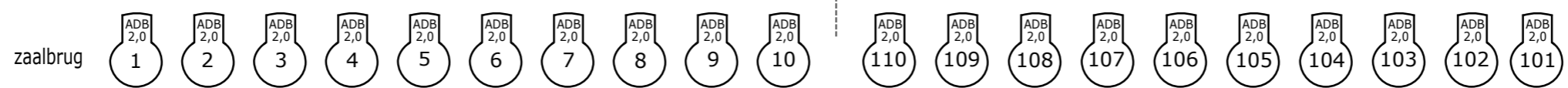

omloop 2 Kw	
191★	
192★	

2 x volgspot Robert Juliat Ivanhoe msr 2500 9°- 21°